





Höp



-  ASH.NGGA004
-  PINK.NGGA004
-  BLACK.NGGA004
-  LIGHTGREY.NGGA004

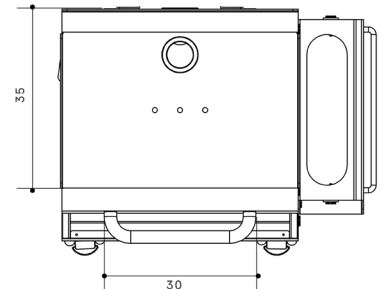
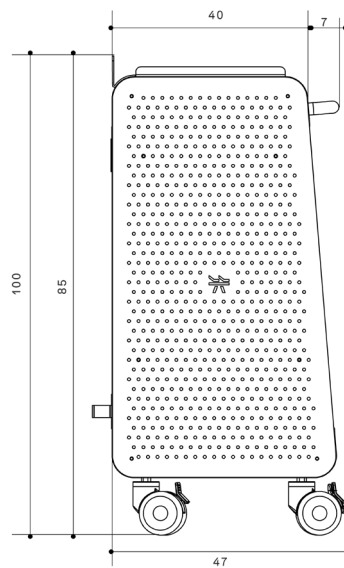
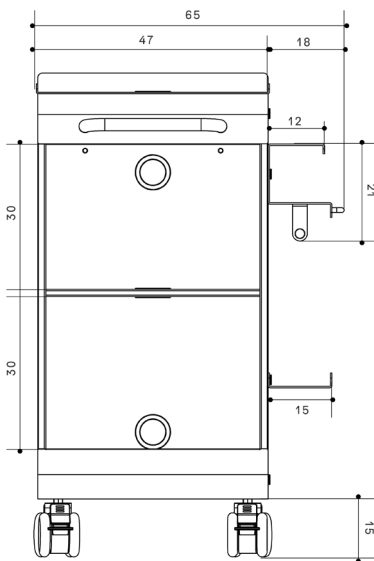

General Specifications

DESCRIPTION

Premium ultra-solid design trolley conceived as a work auxiliary table or for placing high-end equipment. Equipped with 4 wheels turning 360° and a front or rear handle to ensure complete mobility. Wide storage space and sides with perforated metal panel to install various additional storage accessories. Smartly designed to organize the wiring of the devices. Made of painted iron and plywood with melamine sheet on the outer part.

UPHOLSTERY

Metal structure + plywood

DIMENSIONS

100 x 47 x 47 cm

PACKAGING SIZE

52 x 51 x 90 cm

N.W.KG

45

G.W.KG

48